

principio

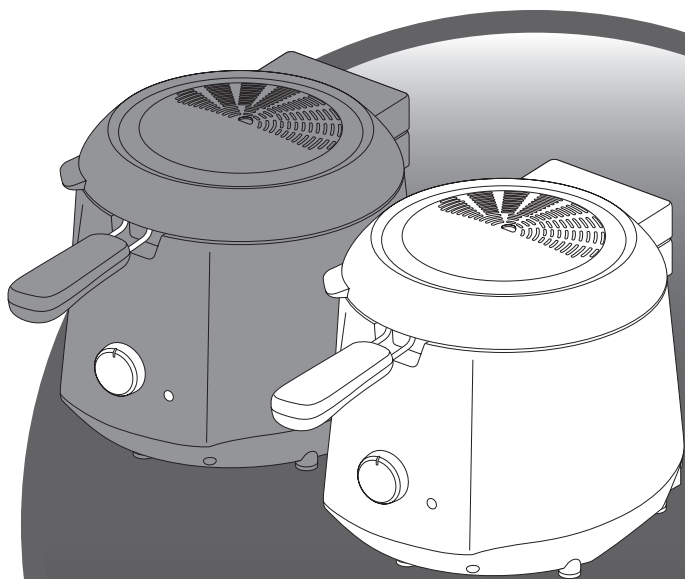

www.groupeseb.com

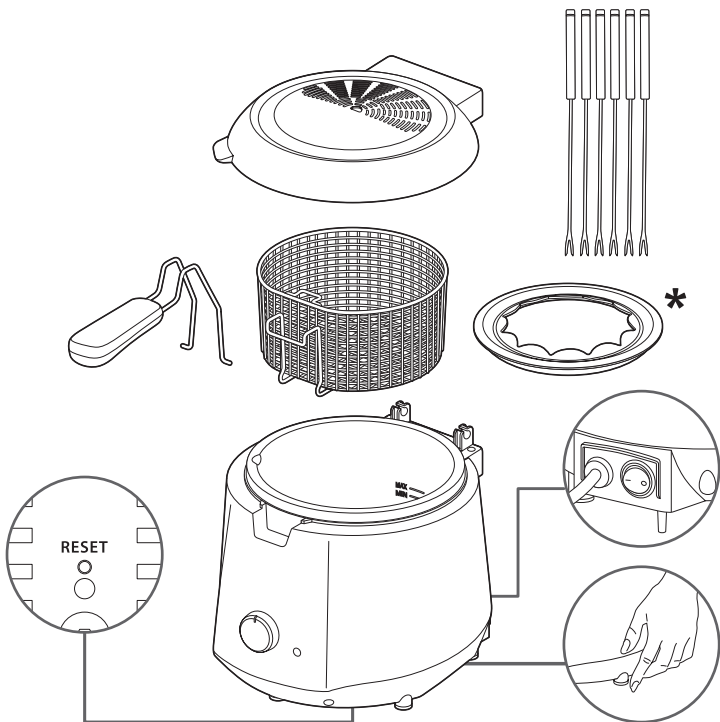

* selon modèle • depending on the model • je nach Modell • a seconda modello • según el modelo •
 consoante os modelos • Ανάλογα με το μοντέλο • В зависимости от модели • залежно від моделі •
 Zależnie od modelu • az egyes modellek szerint • podle modelu • podľa modelu • В зависимости от модели •
 În funcție de model • зависно од модела • zavisno od modela • Oleda na model • بستہ بہ منڈل • حسب المودیل

1



2

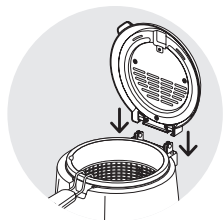
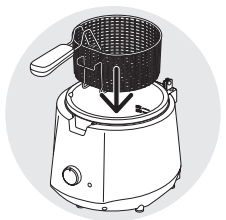
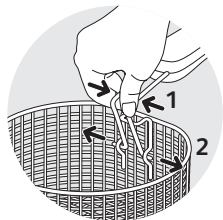
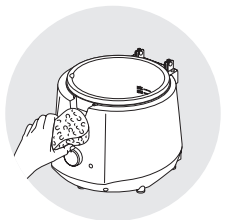
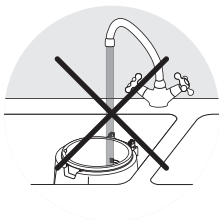
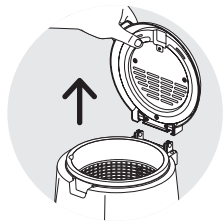
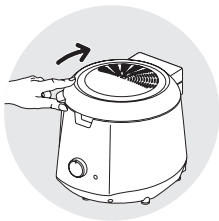



Min 1 L
Max 1.2 L

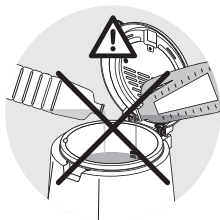
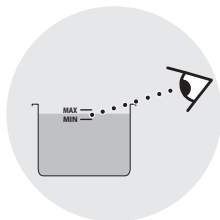
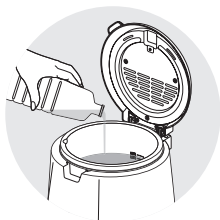



Max 600 g



400 g

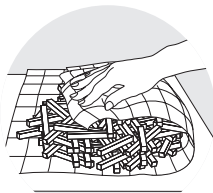

Max 500 g





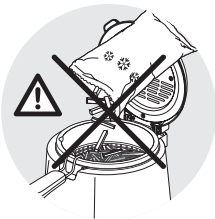
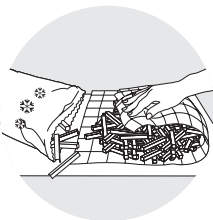

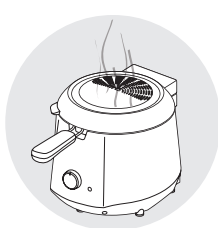
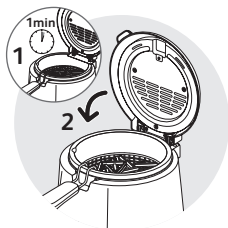
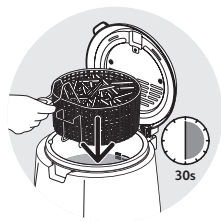
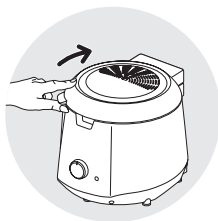
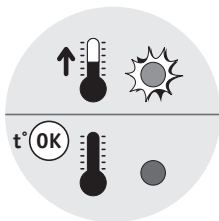
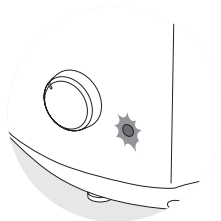
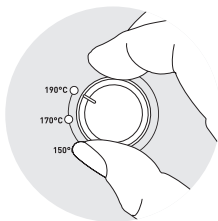
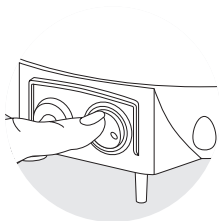
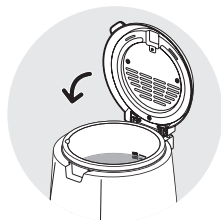













250 g







| | Nb |  |  |  |
|---|---|---|---|---|
|  |  | 600 g | 190°C | 13-16 min |
|  |  | 400 g | 190°C | 11-13 min |
|  | | 50 g | 170 °C | 2-4 min |
|  | Nb |  |  |  |
|  |  | 500 g | 190°C | 11-13 min |
|  |  | 250 g | 190°C | 7-9 min |
|  | | 500 g | 190°C | 4-6 min |
|  | | 500 g | 170°C | 4-6 min |

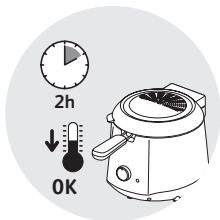
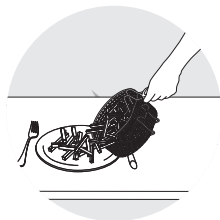
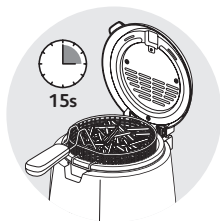
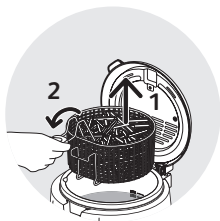
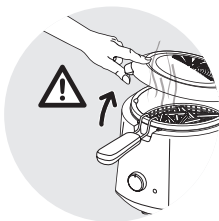
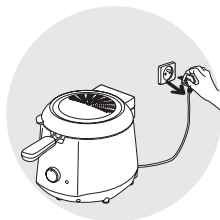
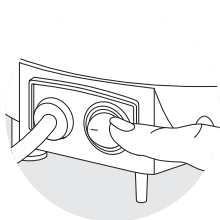
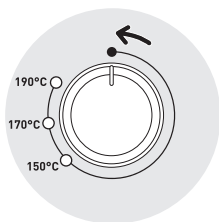

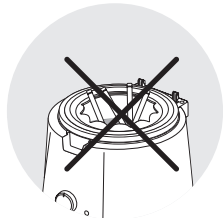
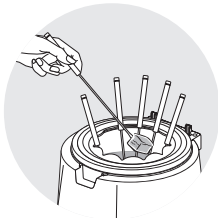
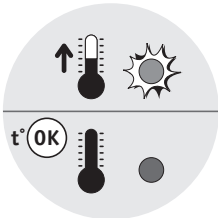
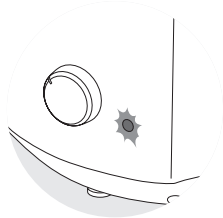
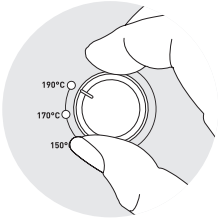
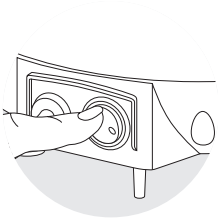
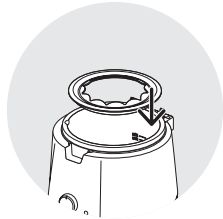
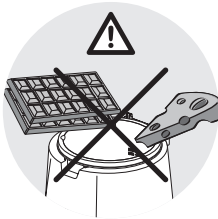
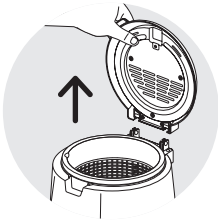

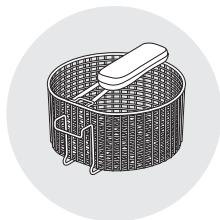
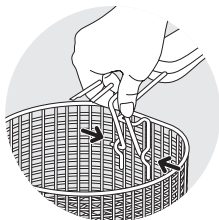
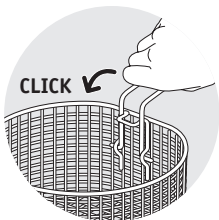
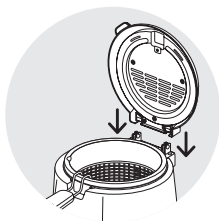
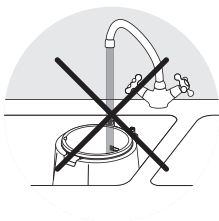
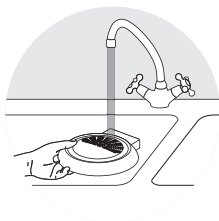
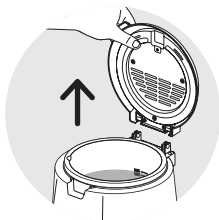
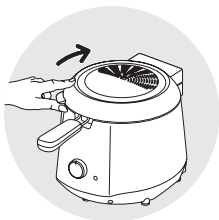

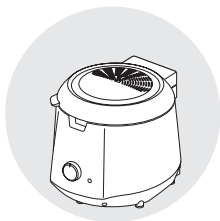

10

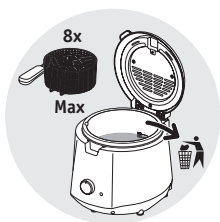

11

11





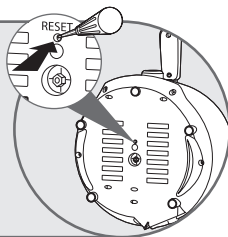
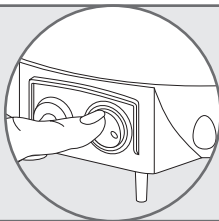
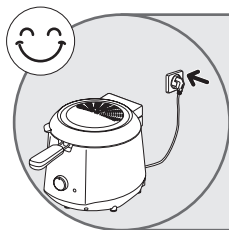
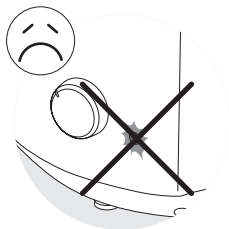

12



INTERNATIONAL GUARANTEE COUNTRY LIST

SMALL HOUSEHOLD APPLIANCES

|  |  |  |  |
|---|---|---|--|
| ARGENTINA | 0800-122-2732 | 2 años 2 years | GROUPE SEB ARGENTINA S.A. Billinghurst 1833 3° C1425DTK Capital Federal Buenos Aires |
| ՀԱՅԱՍՏԱՆ ARMENIA | 010 55-76-07 | 2 տարի 2 years | ՓԲԸ «ԳՐՈՒԴՊՈՍ ՄԵԲ» 125171, ՄՈՍԿՎԱ, ԼԵՆԻՆԳՐԱԴՍԿԱՆ ԽՃՈՒՂԻ, 16A, ՇԽ.Ն.3 |
| AUSTRALIA | 1300307824 | 1 year | GROUPE SEB AUSTRALIA PO Box 7535, Silverwater NSW 2128 |
| ÖSTERREICH AUSTRIA | 01 890 3476 | 2 Jahre 2 years | GROUPE SEB DEUTSCHLAND GmbH Theodor-Stern-Kai 1 60486 Frankfurt am Main |
| البحرين BAHRAIN | 17716666 | 1 year | www.tefal-me.com |
| БЕЛАРУСЬ BELARUS | 017 2239290 | 2 года 2 years | ЗАО «Группа СЕБ-Восток», 125171, Москва, Ленинградское шоссе, д. 16А, стр. 3 |
| BELGIQUE BELGIE BELGIUM | 070 23 31 59 | 2 ans 2 jaar 2 years | GROUPE SEB BELGIUM SA NV 25 avenue de l'Espérance - ZI 6220 Fleurus |
| BOSNA I HERCEGOVINA | Info-linija za potrošače 033 551 220 | 2 godine 2 years | SEB Développement Predstavništvo u BiH Vrazova 8/II 71000 Sarajevo |
| BRASIL BRAZIL | 11 2915-4400 | 1 ano 1 year | SEB COMERCIAL DE PRODUTOS DOMÉSTICOS LTDA Rua Venâncio Aires, 433, Pompéia, São Paulo/SP |
| БЪЛГАРИЯ BULGARIA | 0700 10 330 | 2 години 2 years | ГРУП СЕБ БЪЛГАРИЯ ЕООД бул. България 81 В, ет. 5 1404 София |
| CANADA | 1-800-418-3325 | 1 an 1 year | GROUPE SEB CANADA 345 Passmore Avenue Toronto, ON M1V 3N8 |
| CHILE | 02 2 884 46 06 | 2 años 2 years | GROUPE SEB CHILE Comercial Ltda Av. Providencia, 2331, piso 5, oficina 501 Santiago |
| COLOMBIA | 018000520022 | 2 años 2 years | GROUPE SEB COLOMBIA Apartado Aereo 172, Kilometro 1 Via Zipaquira Cajica Cundinamarca |
| HRVATSKA CROATIA | 01 30 15 294 | 2 godine 2 years | SEB mku & p d.o.o. Sarajevska 29, 10000 Zagreb |
| ČESKÁ REPUBLIKA CZECH REPUBLIC | 731 010 111 | 2 roky 2 years | Groupe SEB ČR s.r.o. Futura Business Park (budova A) Sokolovská 651/136a 186 00 Praha 8 |

| | | | |
|--|---------------------|---------------------|--|
| DANMARK DENMARK | 44 66 31 55 | 2 år 2 years | GRUPE SEB NORDIC AS Tempovej 27 2750 Ballerup |
| مصر EGYPT | 16622 | سنة واحدة 1year | جروب سب ايجيبت القاهرة: ١٢١ شارع الحجاز، مصر الجديدة الإسكندرية: طريق ٤ امايو، سموحة |
| EESTI ESTONIA | 668 1286 | 2 aastat 2 years | Groupe SEB Polska Sp. z o.o. Gdański Business Center II D ul. Inflancka 4C 00-189 Warsaw |
| SUOMI FINLAND | 09 622 94 20 | 2 vuotta 2 years | Groupe SEB Finland Äyritie 12C 01510 Vanta |
| FRANCE Continentale + Guadeloupe, Martinique, Réunion, St- Martin | 09 74 50 47 74 | 2 ans 2 years | GRUPE SEB France Service Consommateur Tefal 112 Ch. Moulin Carron, TSA 92002 69134 ECULLY Cedex |
| DEUTSCHLAND GERMANY | 0212 387 400 | 2 Jahre 2 years | GRUPE SEB DEUTSCHLAND GmbH Theodor-Stern-Kai 1 60486 Frankfurt am Main |
| ELLADA GREECE | 2106371251 | 2 χρόνια 2 years | SEB GROUPE ΕΛΛΑΔΟΣ Α.Ε. Καβαλιεράτου 7 T.K. 145 64 K. Κηφισιά |
| 香港 HONG KONG | 8130 8998 | 1 year | SEB ASIA Ltd. Room 903, 9/F, South Block, Skyway House 3 Sham Mong Road, Tai Kok Tsui, Kowloon Hong-Kong |
| MAGYARORSZÁG HUNGARY | 06 1 801 8434 | 2 év 2 years | GRUPE SEB CENTRAL-EUROPE Kft. 2040 Budaörs, Puskás Tivadar út 14 |
| INDONESIA | +62 21 5793 7007 | 1 year | GRUPE SEB INDONESIA (Representative office) Sudirman Plaza, Plaza Marein 8th Floor JL Jendral Sudirman Kav 76-78, Jakarta 12910, Indonesia |
| ITALIA ITALY | 1 99 207 354 | 2 anni 2 years | GRUPE SEB ITALIA S.p.A. Via Montefeltro, 4 20156 Milano |
| 日本 JAPAN | 0570-077772 | 1 year | 株式会社グループセブジャパン 〒144-0042 東京都大田区羽田旭町11-1 羽田クロノゲート事務棟5F |
| الأردن JORDAN | 5665505 | 1 year | www.tefal-me.com |
| ҚАЗАҚСТАН KAZAKHSTAN | 727 378 39 39 | 2 жыл 2 years | ЖАҚ «Группа СЕБ- Восток» 125171, Мәскеу, Ленинградское шоссесі, 16А, 3 үйі |
| 한국어 KOREA | 1588-1588 | 1 year | (유)그룹 세브 코리아 서울시 종로구 청계천로 35 관정빌딩 2층 03188 |

| | | | |
|------------------------------|--|---------------------|--|
| الكويت KUWAIT | 1807777 Ext :2104 | 1 year | www.tefal-me.com |
| LATVJA LATVIA | 6 616 3403 | 2 gadi 2 years | Groupe SEB Polska Sp. z o.o. Gdański Business Center II D ul. Inflancka 4C 00-189 Warsaw |
| لبنان LEBANON | 4414727 | 1 year | www.tefal-me.com |
| LIETUVA LITHUANIA | 5 214 0057 | 2 metai 2 years | Groupe SEB Polska Sp. z o.o. Gdański Business Center II D ul. Inflancka 4C 00-189 Warsaw |
| LUXEMBOURG | 0032 70 23 31 59 | 2 ans 2 years | GROUPE SEB BELGIUM SA NV 25 avenue de l'Espérance - ZI 6220 Fleurus |
| МАКЕДОНИЈА MACEDONIA | (02) 20 50 319 | 2 години 2 years | ГРУП СЕБ БЪЛГАРИЈА ЕООД бул. България 81 В, ет. 5 1404 София |
| MALAYSIA | 603 7802 3000 | 2 years | GROUPE SEB MALAYSIA SDN. BHD Unit No. 402-403, Level 4, Uptown 2, No. 2, Jalan SS21/37, Damansara Uptown, 47400, Petaling Jaya, Selangor D.E Malaysia |
| MEXICO | (01800) 112 8325 | 1 año 1 year | Groupe SEB México, S.A. DE C.V. Calle Goldsmith 38-401, Polanco Ciudad de México C.P. 11560, México |
| MOLDOVA | 22 929249 | 2 роки 2 years | ТОВ «Груп СЕБ Україна» 02121, Харківське шосе, 201-203, 3 поверх, Київ, Україна |
| NEDERLAND The Netherlands | 0318 58 24 24 | 2 jaar 2 years | GROUPE SEB NEDERLAND B.V. De Schutterij 27 3905 PK Veendaal |
| NEW ZEALAND | 0800 700 711 | 1 year | GROUPE SEB NEW ZEALAND PO Box 17 – 298, Greenlane, 1546 Auckland New Zealand |
| NORGE NORWAY | 815 09 567 | 2 år 2 years | GROUPE SEB NORDIC AS Tempovej 27 2750 Ballerup |
| عمان سلطنة OMAN | 24703471 | 1 year | www.tefal-me.com |
| POLSKA POLAND | 801 300 420 koszt jak za połączenie lokalne | 2 lata 2 years | Groupe SEB Polska Sp. z o.o. Gdański Business Center II D ul. Inflancka 4C 00-189 Warsaw |
| PORTUGAL | 808 284 735 | 2 anos 2 years | GROUPE SEB IBÉRICA SA Urb. da Matinha Rua Projectada à Rua 3 Bloco1 - 3° B/D 1950 - 327 Lisboa |

| | | | |
|--|-----------------|-----------------------------|---|
| قطر QATAR | 44485555 | 1 year | www.tefal-me.com |
| REPUBLIC OF IRELAND | 01 677 4003 | 1 year | GROUPE SEB IRELAND Unit B3 Aerodrome Business Park, College Road, Rathcoole, Co. Dublin |
| ROMANIA | 0 21 316 87 84 | 2 ani 2 years | GROUPE SEB ROMANIA Str. Ernil Pangratti nr. 13 011881 București |
| РОССИЯ RUSSIA | 495 213 32 30 | 2 года 2 years | ЗАО «Группа СЕБ-Восток», 125171, Москва, Ленинградское шоссе, д. 16А, стр. 3 |
| المملكة العربية السعودية SAUDI ARABIA | 920023701 | 2 years | www.tefal-me.com |
| SRBIJA SERBIA | 060 0 732 000 | 2 godine 2 years | SEB Developpement Đorđa Stanojevića 11b 11070 Novi Beograd |
| SINGAPORE | 6550 8900 | 2 years | GROUPE SEB SINGAPORE Pty Ltd. 59 Jalan Pemipin, #04-01/02 L&Y Building Singapore 577218 |
| SLOVENSKO SLOVAKIA | 232 199 930 | 2 roky 2 years | GROUPE SEB Slovensko, spol. s r.o. Cesta na Senec 2/A 821 04 Bratislava |
| SLOVENIJA SLOVENIA | 02 234 94 90 | 2 leti 2 years | SEB d.o.o. Gregorčičeva ulica 6 2000 MARIBOR |
| SOUTH AFRICA | www.tefal.co.za | 1 year | www.tefal.co.za |
| ESPAÑA SPAIN | 902 31 24 00 | 2 años 2 years | GROUPE SEB IBÉRICA S.A. C/ Almogàvers, 119-123, Complejo Ecourban 08018 Barcelona |
| SVERIGE SWEDEN | 08 594 213 30 | 2 år 2 years | Tefal Sverige, Löfströms allé 5, 172 66 Sundbyberg |
| SUISSE SCHWEIZ SWITZERLAND | 044 837 18 40 | 2 ans 2 Jahre 2 years | GROUPE SEB SCHWEIZ GmbH Thurgauerstrasse 105 8152 Glattpark |
| ประเทศไทย THAILAND | 02 769 7477 | 2 years | GROUPE SEB THAILAND 2034/66 Italthai Tower, 14th Floor, n° 14-02, New Phetchburi Road, Bangkapi, Huaykwang, Bangkok, 10320 |
| TÜRKIYE TURKEY | 444 40 50 | 2 YIL 2 years | GROUPE SEB ISTANBUL AS Dereboyu Cd. Bilim Sk. Sun Plaza No:5 K:2 Maslak 34398 Istanbul |
| المتحدة العربية الامارات UAE | 8002272 | 1 year | www.tefal-me.com |
| Україна UKRAINE | 044 300 13 04 | 2 роки 2 years | ТОВ «Груп СЕБ Україна» 02121, Харківське шосе, 201-203, 3 поверх, Київ, Україна |

| | | | |
|-----------------------|---------------|-------------------|---|
| UNITED KINGDOM | 0345 602 1454 | 1 year | GRUPE SEB UK LTD Riverside House, Riverside Walk Windsor, Berkshire, SL4 1NA |
| U.S.A. | 800-395-8325 | 1 year | GRUPE SEB USA 2121 Eden Road Millville, NJ 08332 |
| VENEZUELA | 0800-7268724 | 2 años 2 years | GRUPE SEB VENEZUELA Av Eugenio Mendoza, Centro Letonia, Torre ING Bank, Piso 15, Ofc 155 Urb. La Castellana, Caracas |

12/10/2016

INTERNATIONAL GUARANTEE

Date of purchase / Date d'achat / Fecha de compra / Købsdato / Ostopäivä / Kjøpsdato / Inköpsdatum / Ostukuupäev / Pirkuma datums / Isigijimo data / Data zakupu / Datum izročitve blaga / Datum kupovine / Vásárlás dátuma / Data achiziției / Дата на закупуване / Дата продажи / Чынданрһ ор. / Дата продажи / Сатылган күні / 購入日 / วันที่ซื้อ / 구입일자 / Датум на купување :

Product reference / Référence produit / Referencia del producto / Referencenummer / Tuotenumero / Artikelnummer / Produktreferens / Toote viitenumber / Produkta atsauces numurs / Gaminio numeris / Referenca produktu / Oznaka proizvoda / Tip aparata / Készülék típusa / Cod produs / Модел / Модель / Унһл / Модель / Υλιци / 製品リファレンス番号 / รุ่นผลิตภัณฑ์ / 제품명 / Податоци за производот:

Retailer name and address / Nom et adresse du revendeur / Nombre y dirección del minorista / Forhandler navn & adresse / Jälleenmyyjän nimi ja osoite / Forhandler navn og adresse / Återförsäljarens namn och adress / Müüja kauplus ja aadress / Veikala nosaukums un adrese / Parduotuvės pavadinimas ir adresas / Nazwa i adres sprzedawcy /

Distributor stamp / Cachet / Sello del distribuidor / Forhandler stempel / Jälleenmyyjän leima / Forhandler stempel / Återförsäljarens stämpel / Tempel / Zīmogs / Antspaudas / Pieczęć sprzedawcy / Pečat distributera / Pečat trgovine / Forgalmazó pecsétje / Ştampila vânzătorului / Печат на търговския обект / Печатка продавця / Чӱһр. / Печать продавца / Сатушынын мөри / 販売店印 / ตราประทับของห้าง/วันที่ซื้อ / 소매점 직인 / Печат на дистрибутор :

NC00145862